

Adriano



Struttura portante: in legno rivestita con poliuretano espanso a densità differenziate e sistema di molleggio a cinghie elastiche incrociate.

Imbottitura: cuscini di seduta e di schienale in poliuretano espanso a densità differenziate.

Schienale con meccanismo regolabile in varie posizioni.

Meccanica: disponibile con sistema recliner elettrico integrato.

Piedini: in metallo, disponibile con finitura cromato lucido o verniciata antracite h 13,5 cm.

Frame: wooden frame padded with differentiated-density polyurethane foam and spring system with intertwined elastic straps.

Cushions: seat and back cushions made from differentiated-density polyurethane foam.

Adjustable backrest in different positions.

Recliner: available electric powered recliner.

Feet: shiny metal or anthracite varnished feet, h 13,5 cm.

DIVANI - SOFAS

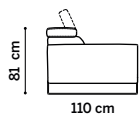

cod. **020**



cod. **030**



cod. **048**

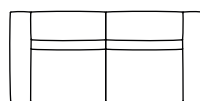
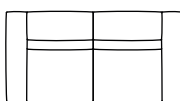
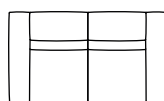

DIVANI TERMINALI - END SOFAS

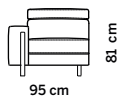
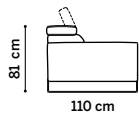

cod. **011 LHF**
cod. **012 RHF**

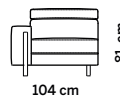

cod. **166 LHF**
cod. **167 RHF**

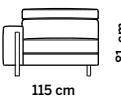

cod. **101 LHF**
cod. **102 RHF**

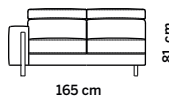

cod. **021 LHF**
cod. **022 RHF**

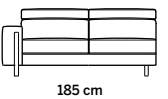

cod. **031 LHF**
cod. **032 RHF**

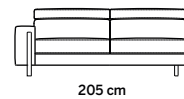

cod. **056 LHF**
cod. **057 RHF**

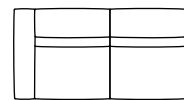
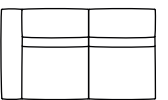
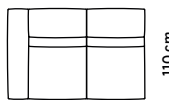
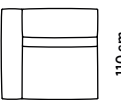
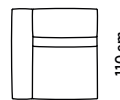
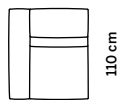

DIVANI RELAX - RECLINER SOFAS

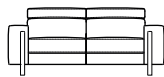
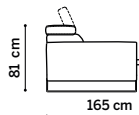

cod. **083**



cod. **080**



cod. **116**

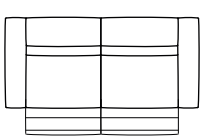
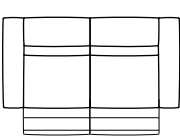
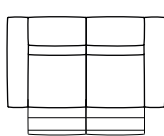

DIVANI TERMINALI 1 RELAX - END SOFAS 1 RECLINER

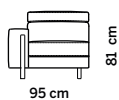
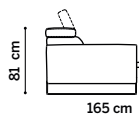

cod. **135 LHF**
cod. **136 RHF**

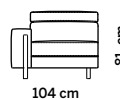

cod. **169 LHF**
cod. **170 RHF**

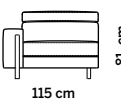

cod. **132 LHF**
cod. **133 RHF**

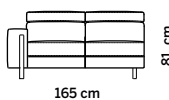

cod. **130 LHF**
cod. **131 RHF**

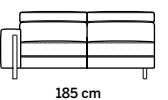

cod. **128 LHF**
cod. **129 RHF**

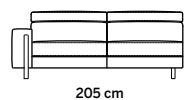

cod. **332 LHF**
cod. **333 RHF**

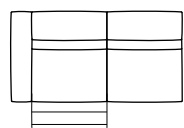
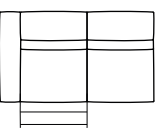
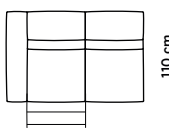
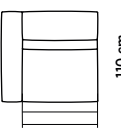
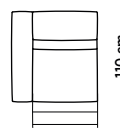
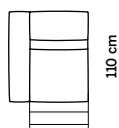

Adriano



Struttura portante: in legno rivestita con poliuretano espanso a densità differenziate e sistema di molleggio a cinghie elastiche incrociate.

Imbottitura: cuscini di seduta e di schienale in poliuretano espanso a densità differenziate.

Schiena con meccanismo regolabile in varie posizioni.

Meccanica: disponibile con sistema recliner elettrico integrato.

Piedini: in metallo, disponibile con finitura cromato lucido o verniciata antracite h 13,5 cm.

Frame: wooden frame padded with differentiated-density polyurethane foam and spring system with intertwined elastic straps.

Cushions: seat and back cushions made from differentiated-density polyurethane foam.

Adjustable backrest in different positions.

Recliner: available electric powered recliner.

Feet: shiny metal or anthracite varnished feet, h 13,5 cm.

DIVANI TERMINALI 2 RELAX - END SOFAS 2 RECLINER

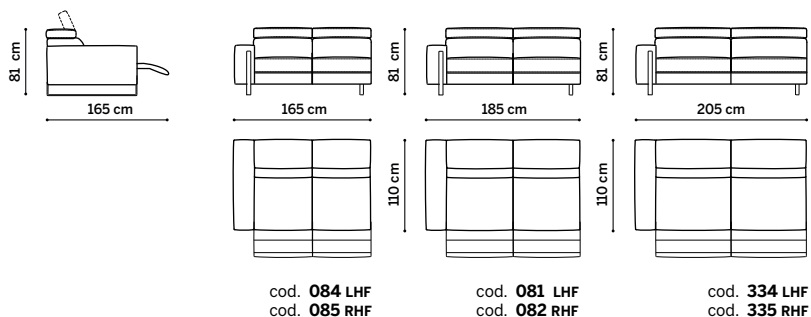

ANGOLO - CORNER

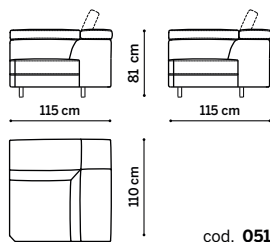

CHAISE LONGUE

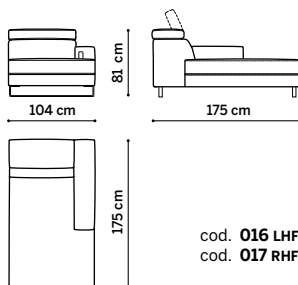

MERIDIEN

