



■ Vers. 009



■ Vers. 003



■ Vers. 016+201



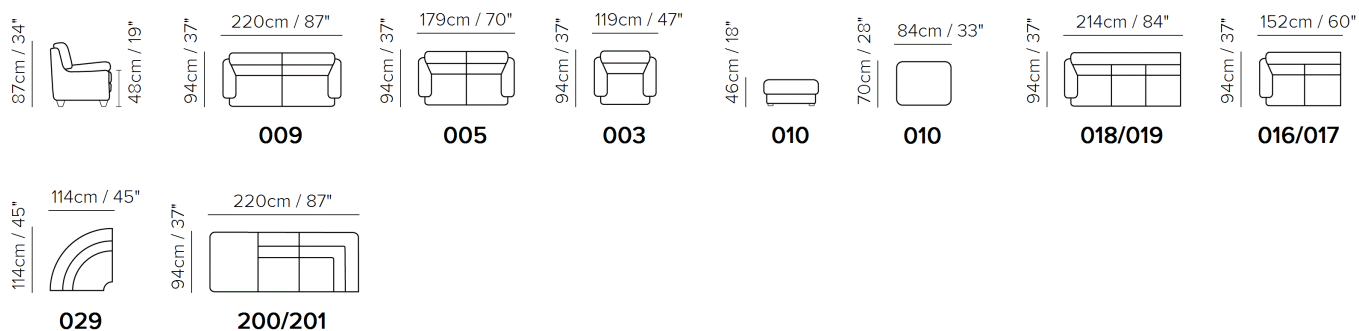

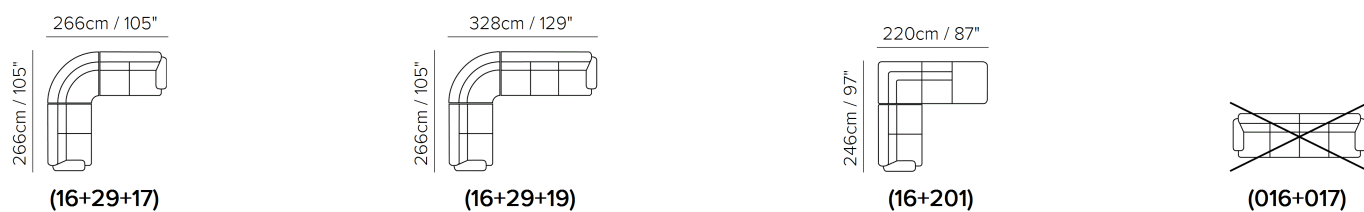

## SCHEMATICS



## COMPOSITION EXAMPLES



## TECHNICAL INFORMATION

	<b>COVERING</b>	Mix Next Leather <input checked="" type="checkbox"/>	Leather <input checked="" type="checkbox"/>	Soft Cover <input checked="" type="checkbox"/>		
	<b>LEGS</b>	Metal <input checked="" type="checkbox"/>	Wood <input type="checkbox"/>	Upholstered <input type="checkbox"/>	Castors <input type="checkbox"/>	Plastic <input type="checkbox"/>
	<b>FILLING</b>	Arms <input checked="" type="checkbox"/> Fiber <input type="checkbox"/> Foam <input type="checkbox"/> Feather/Fiber Mix <input type="checkbox"/> Feather	Seat cushion <input type="checkbox"/> Fiber <input checked="" type="checkbox"/> Foam <input type="checkbox"/> Feather/Fiber Mix <input type="checkbox"/> Feather	Back cushion <input checked="" type="checkbox"/> Fiber <input type="checkbox"/> Foam <input type="checkbox"/> Feather/Fiber Mix <input type="checkbox"/> Feather		
	<b>COMFORT</b>	Firm Comfort <input checked="" type="checkbox"/>	Standard Comfort <input checked="" type="checkbox"/>			
	<b>FUNCTION</b>	Bed <input type="checkbox"/>	Electric motion <input type="checkbox"/>	Motion <input type="checkbox"/>	Recliner <input type="checkbox"/>	Sliding <input type="checkbox"/>
	<b>OPTIONS</b>	Nails <input type="checkbox"/>	Contrast Stitching <input checked="" type="checkbox"/>	Removable <input type="checkbox"/>		

## NOTES

- STITCHING ON THE SOFA DIFFERS ALL LEATHER AND/OR LEATHER-BONDED MIX: MODEL IN LEATHER-BONDED MIX HAS MORE CUTS.
- All arms, back and seat surfaces are covered in Top Grain.
- This model is available with split leather exterior covering (Side, Rear and Front Panels)
- Tight Seat Cushion (the seat cushions of the models are fixed to the frame)
- Tight Back Cushion (the back cushions of the models are fixed to the frame)
- No Leather Side (the sectional pieces have the side covered with fabric and not leather)
- Wood Frame
- Without Feet Assembled (the feet will be in a bag inside the package)
- Plastic Wrap (the model will be wrapped in a plastic bag)
- Feet available in metal finishing 75 (Glazed Nickel)

## NOTES

---